

# 1 Connect

## A Placement

Proper speakers system placement is important to ensure optimum sound performance.

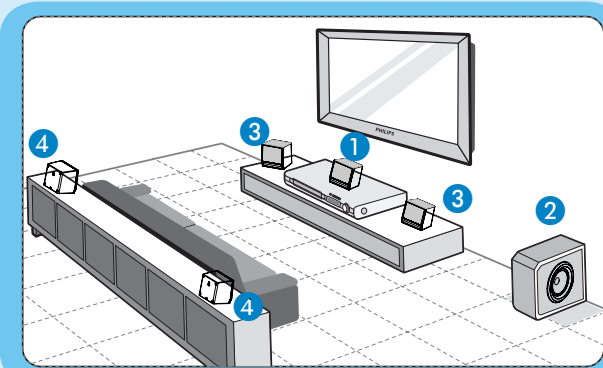

- 1 Place the center speaker above or close to the TV.
- 2 Place the subwoofer on the floor, at least one meter away from the TV.
- 3 Place the front speakers at equal distances from the TV.
- 4 Place the rear speakers at normal listening ear level.

## B Connect the radio antennas

Keep the antennas away from the electronic devices to prevent unwanted interference.

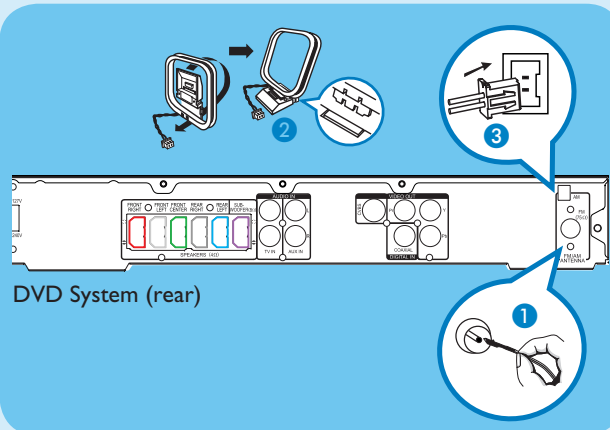

- 1 Connect the FM antenna to the FM jack. Extend the wire and fix its end to the wall.
- 2 Unfold the AM loop antenna and fix the claw into the slot.
- 3 Connect the AM loop antenna to the AM jack. Place the AM loop antenna on a shelf, or attach it to a stand or wall.

## C Connect the speakers and subwoofer

Connect the various colored plugs from the speakers and subwoofer to the same colored jacks at the rear of the DVD system.

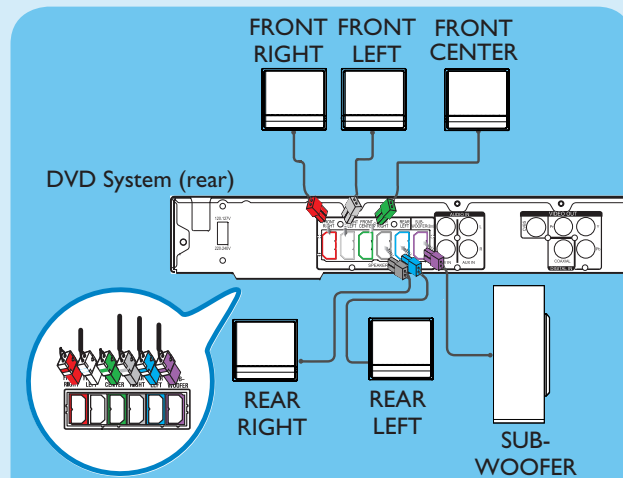

## D Connect the DVD system to TV

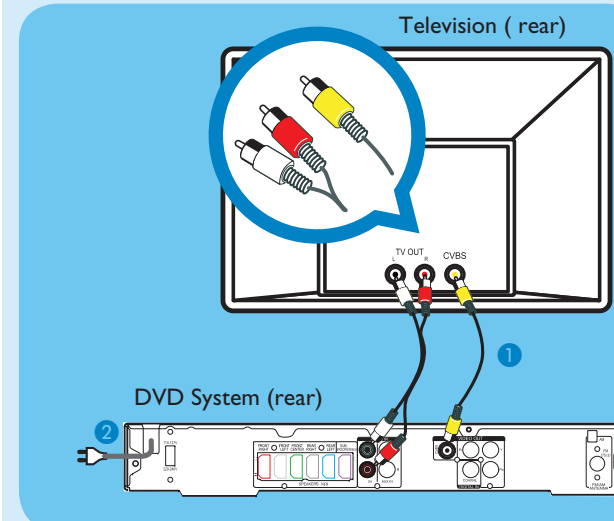

- 1 Use the supplied composite video cable to connect the CVBS jack on this DVD system to the VIDEO IN jack on your TV.
- 2 Plug in the power cable from the DVD system to an AC power outlet.

**Note** It is important to connect the DVD system directly to your TV.

## E Connect the audio from other device to DVD system (optional)

Use the red and white audio cables to connect the AUX IN (R/L) jacks on this DVD system to the AUDIO output jacks on your Audio/Video device (for example, DVD recorder, VCR).

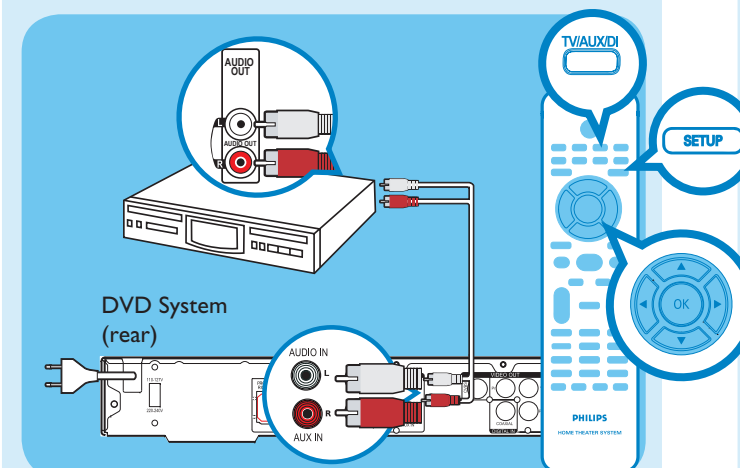

**Note** Press TV/AUX/DI on the remote control to get the sound output from the speakers system when watching the TV program.

# 2 Set up

## A Finding the viewing channel

- 1 Press **STANDBY ON** on the DVD system.
- 2 Press **SOURCE** on the DVD system until "DISC" appears on the display panel.

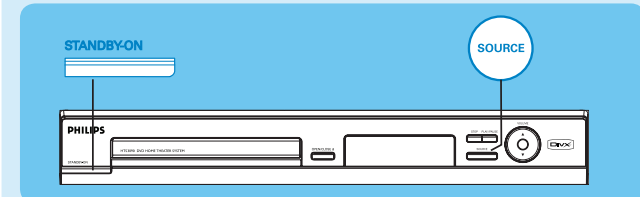

- 3 Turn on the TV. Use the TV's remote control to select the correct viewing channel for the DVD system. You should see the blue DVD background on the TV.

**Note** To search for the correct viewing channel, press the Channel Down button on the TV's remote control repeatedly (or AV, SELECT, or button) until you see the blue DVD background.

## B Select the display language on the screen

- 1 Press **SETUP**. The setup menu appears. Use ◀▶▼▲ keys on the remote control to navigate in the menu.
- 2 Highlight **MENU LANG** icon and press ▼. Move to **ENGLISH** in the menu and press ▶.

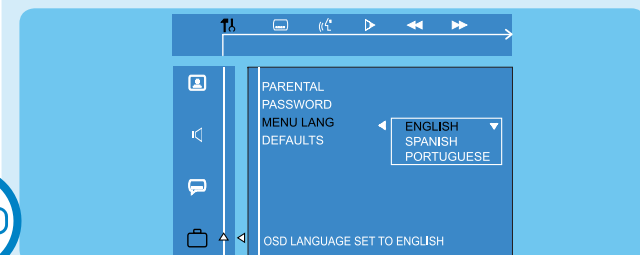

- 3 Move to { MENU LANG } in the menu and press ▶.
- 4 Use ▼▲ keys to select a language option in the menu and press **OK** to confirm.
- 5 Press **SETUP** to exit.

**Note** The language set here is only for the menus that are shown on the TV while operating this DVD system, not for the DVD disc menu.

There are various setup options (Audio Setup, Video Setup, Preference Setup) available on this DVD system. Refer to the user manual for more information.

# 3 Enjoy

# Quick Start Guide



- 1 Connect
- 2 Set up
- 3 Enjoy

## What's in the box?

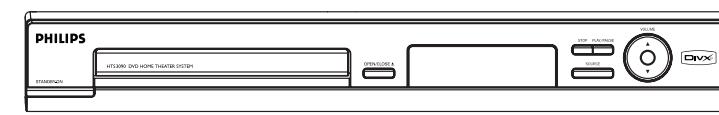

DVD system

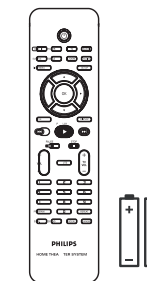

Remote Control and 2 batteries

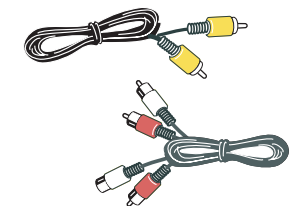

1 video cable  
1 audio cable

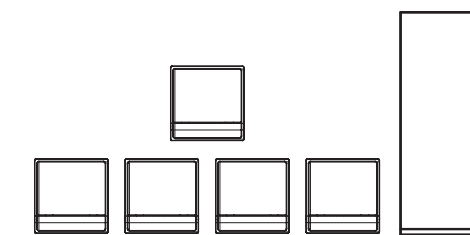

1 center, 2 front, 2 rear speakers and subwoofer



FM wire antenna

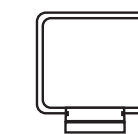

AM/MW loop antenna



Adaptor

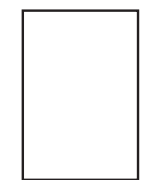

User Manual

## Start disc playback

- 1 Press **OPEN CLOSE** to open the disc tray. Load a disc and close the disc tray.

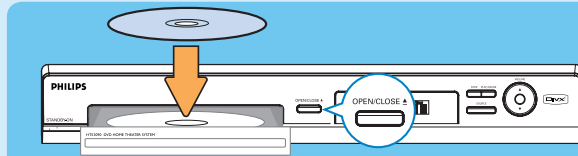

- 2 Playback will start automatically.
- 3 If the disc menu appears, use **▼▲** keys to select an option in the menu and press **PLAY ►** to start playback.
- 4 Press **STOP ■** to stop playback.

**Note** When you press PLAY button again, the playback will resume from its last stopped point. To start playback from the beginning, you have to press STOP button two times to cancel the resume mode, then press PLAY button.



## Listen to radio

- 1 Press **TUNER**. The display panel will show "AUTO INSTALL PRESS PLAY".
- 2 Press **PLAY ►** until "START ..." appears on the display panel. All the available radio stations with strong reception signal will be stored automatically.

**Note** This feature is only available for the first time setup. If you wish to reinstall all the radio stations, hold down the PROGRAM button on the remote control.

- 3 Once complete, use **◀▶** keys to select a preset radio station.
- 4 To delete a preset radio station, hold down **STOP ■** until "DELETED" appears.

## Experience surround sound

- 1 Press **SURR** to switch between stereo and multi-channel.
- 2 Press **SOUND** to select either CONCERT, DRAMA, ACTION, SCI-FI, CLASSIC, JAZZ, ROCK or DIGITAL preset digital sound effects.

## Troubleshooting

For more troubleshooting tips, see the user manual.

### No picture.

- Press DISC button on the remote control.
- Check the connection to the TV and ensure the plugs are firmly in place.

### No sound.

- Adjust the volume.
- Check the speaker connections and settings.
- Check the audio connections and press SOURCE button to select the correct input source.
- The center and rear speakers operate only in multi-channel surround mode. Press SURR button to select multi-channel surround output.
- When playback of DTS track, press AUDIO to select other audio track.

### The DVD system does not work.

- Disconnect the power cord from the power outlet for a few minutes. Reconnect the power cord and try again.

## Need help?

### User Manual

See the user manual that came with your Philips DVD System

### Online

Go to [www.philips.com/support](http://www.philips.com/support)



2006 © Koninklijke Philips N.V.  
All rights reserved.

[www.philips.com](http://www.philips.com)

# PHILIPS